

SDM72D-M

Three Phase Four Wire Energy Meter



- Measures active kWh & W.
- Resettable partial energy
- Bi-directional measurement IMP & EXP
- Pulse Output
- RS485 Modbus

User Manual V1.5

2017

Introduction

The SDM72D-M is digital three phase 4 wire energy meter with a white back-lighted LCD screen for perfect reading. The unit measures and displays active energy (kWh) and power (W), imported and exported. A resettable partial energy is provided, so the user can easily check the energy imported and energy exported during a certain period. SDM72D-M supports max.100A direct connection, saves the cost and avoid the trouble to connect external CTs, giving the unit a cost-effective and east operation. Built-in interfaces provide pulse and RS485 Modbus RTU outputs. Configuration is password protected.

PART 1 Specification

General Specifications

Voltage AC (Un)	3x230(400)V
Voltage Range	80~120% Un
Base Current (Ib)	10A AC
Max. Current (Imax)	100A AC
Mini Current (Imin)	5% of Ib AC
Starting current	0.4% of Ib
Power consumption	<2W/10VA
Frequency	50/60Hz
AC voltage withstand	4KV for 1 minute
Impulse voltage withstand	6KV-1.2uS waveform
Overcurrent withstand	30max 0I for 0.01s
Pulse output rate	1000imp/kWh (Pulse 2)
Display	LCD with backlit
Max. Reading	999999.9kWh
Active energy	Class 1 IEC62053-21 Class B EN50470-3

Unit Characteristics

The Unit can measure and display:

- Power
- Active energy imported and exported

Pulse output indicates real-time energy measurement. An RS485 output allows remote monitoring from another display or a computer.

RS485 Serial – Modbus RTU

This unit uses an RS485 serial port with Modbus RTU protocol to provide a means of remotely monitoring and controlling the Unit

Set-up screens are provided for setting up the RS485 port.

Pulse output

The unit provides pulse output for active kWh. The Pulse output is passive type.

The pulse out is fixed up with total kWh. The constant is 1000imp/kWh.

RS485 Output for Modbus RTU

For Modbus RTU, the following RS485 communication parameters can be configured from the Set-up menu:

Baud rate 1200,2400, 4800, 9600

Parity none (default)/odd/even

Stop bits 1 or 2

RS485 network address *nnn* – 3-digit number, 001 to 247

Modbus™ Word order Hi/Lo byte order is set automatically to normal or reverse. It cannot be configured from the set-up menu.

Environment

Operating temperature	-25°C to +55°C
Storage and transportation temperature	-40°C to +70°C
Reference temperature	23°C ± 2°C
Relative humidity	0 to 95%, non-condensing
Altitude	up to 3000m
Warm up time	10s
Installation category	CAT III
Mechanical Environment	M1
Electromagnetic environment	E2
Degree of pollution	2

Mechanics

Din rail dimensions	72x100x66 (WxHxD) DIN 43880
Mounting	DIN rail 35mm
Sealing	IP51 (indoor)
Material	self-extinguishing UL94V-0

PART 2 Operation



Initialization Display

When it is powered on, the meter will initialize and do self-checking.

 <p>The display shows 'Total' and 'Min dmd' at the top. Below are 'Imp' and 'Exp' with a large '0' and a left arrow. At the bottom are 'L1 L2 L3' and 'A h kWh'. The main display area shows '000.00.00'.</p>	<p>Full Screen</p>
 <p>The display shows '05' on the left and '00.01' on the right.</p>	<p>Software Version</p>
 <p>The display shows '1' on the left and '1000' on the right.</p>	<p>Pulse constant</p>
 <p>The display shows 'Total' at the top, '000069.8' in the middle, and 'kWh' at the bottom.</p>	<p>Total active energy(kWh) Total=Import+ Export Max read: 999999.9 kWh</p>



Buttons function







There are two buttons on the front panel.



	>Scroll the display for data checking. >Changing option at Set-up mode >Exit the Set-up mode
	>Set-up mode entry >Confirmation

Scroll display

After initialization and self-checking program, the meter display the measured values. The default page is total kWh. If the user wants to check other information, please press the scroll button  on the front panel.

















	Total active energy(kWh) Total=Import+ Export
	import energy
	export energy









 <p>The LCD display shows the word "Total" at the top. Below it, the number "000 178.5" is displayed in a large digital font, with "kWh" written below the decimal part. A small icon of a left-pointing arrow with a "0" is visible on the left side of the display.</p>	<p>Total partial energy(kWh) Total=Import+ Export</p>
 <p>The LCD display shows the word "Imp" at the top. Below it, the number "000 155.1" is displayed in a large digital font, with "kWh" written below the decimal part. A small icon of a left-pointing arrow with a "0" is visible on the left side of the display.</p>	<p>Import partial energy</p>
 <p>The LCD display shows the word "Exp" at the top. Below it, the number "000023.4" is displayed in a large digital font, with "kWh" written below the decimal part. A small icon of a left-pointing arrow with a "0" is visible on the left side of the display.</p>	<p>export partial energy</p>
 <p>The LCD display shows the word "Total" at the top. Below it, the number "00000" is displayed in a large digital font, with "W" written below the number.</p>	<p>Total active power</p>
 <p>The LCD display shows the word "Imp" at the top. Below it, the number "00000" is displayed in a large digital font, with "W" written below the number.</p>	<p>Import active power</p>
 <p>The LCD display shows the word "Exp" at the top. Below it, the number "00000" is displayed in a large digital font, with "W" written below the number.</p>	<p>Export active power</p>
 <p>The LCD display shows the letter "C" at the top. Below it, the number "1000" is displayed in a large digital font.</p>	<p>Pulse constant</p>

	Modbus Address
	Baud Rate
	Parity

Set-up Mode

To get into Set-up Mode, the user need press the “Enter” button  for 3 seconds.

Page	Display	Descriptions
1		<p>Password</p> <p>To get into Set-up mode, it asks a password confirmation. Default password: 1000</p> <p>Use  and  to enter correct password.</p>
		<p>The entering information is wrong. The operation fails.</p>
2		<p>Keep pressing  for 3 seconds, the current selection will flash, use  and  to change the Modbus address. Options: 1~247</p> <p>Keep press  for 3s to confirm the selection.</p>
3		<p>Keep pressing  for 3 seconds, the current selection will flash, use  and  to change the Baud rate. Options: 1.2k, 2.4k,4.8k,9.6k (default)</p> <p>Keep press  for 3s to confirm the selection.</p>
4		<p>Keep pressing  for 3 second, the current selection will flash, use  and  to change the Parity. Options: EVEN,ODD,NONE (default)</p>

		Keep press  for 3s to confirm the selection.
5		Use  to select the Password option. Keep pressing  for 3 seconds, the current selection will flash, use  and  to enter the new password. The range is from 0001 to 9999.
6		Keep press  for 3s to confirm the selection.

Keep pressing button  to exit the set-up mold.

Wiring diagram

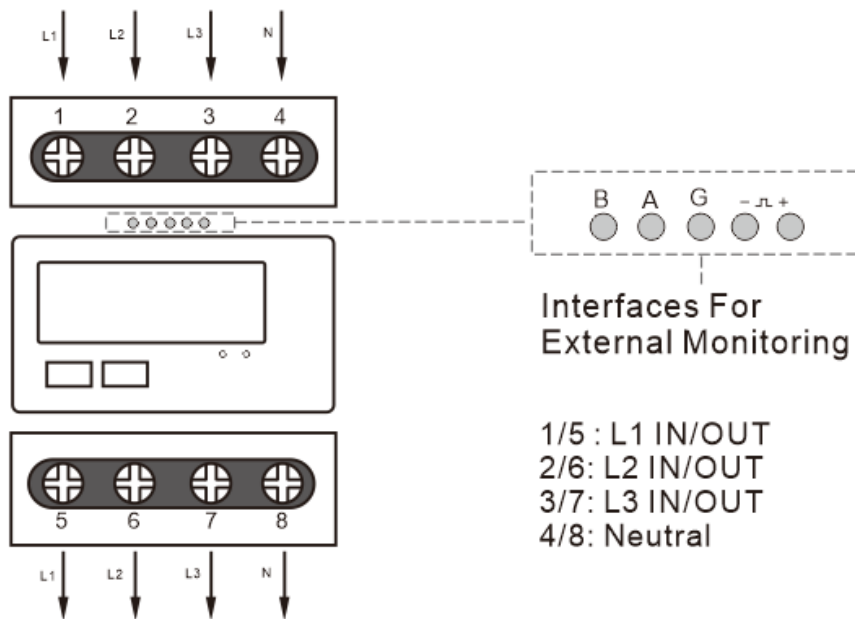

3 phase 4 wire

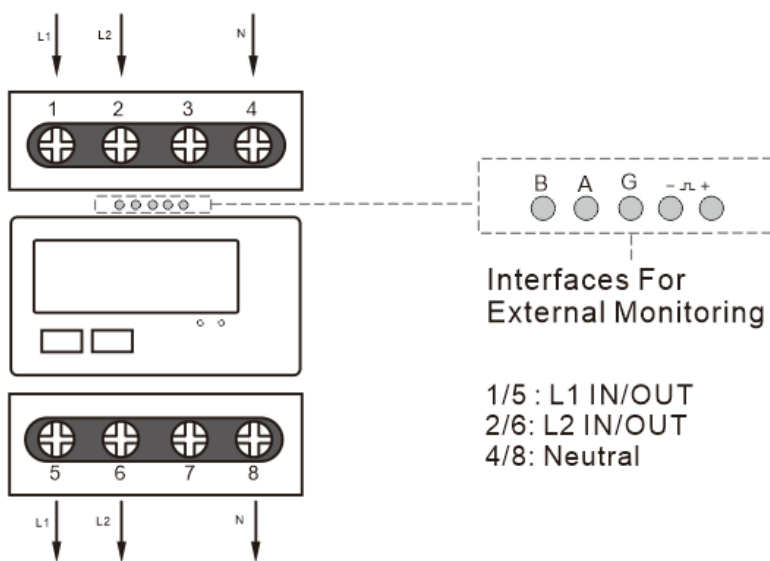

2 phase 3 wire

Dimensions

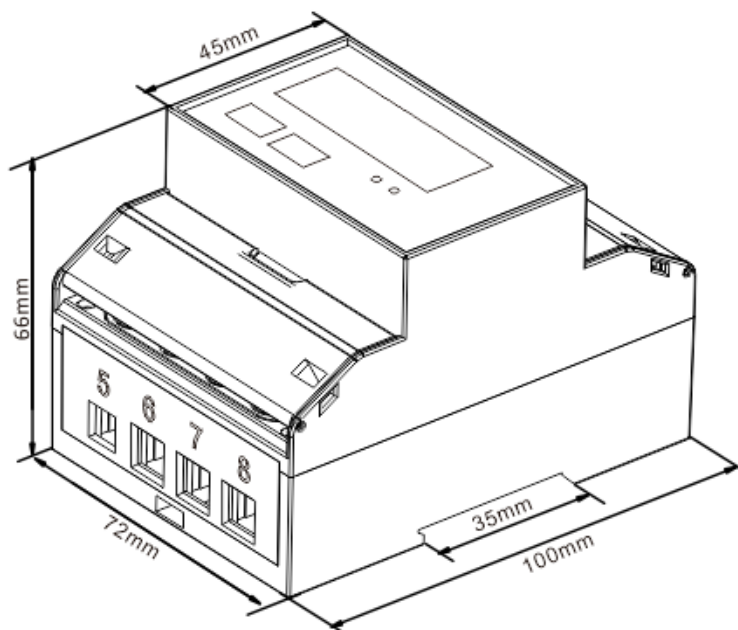

Installation

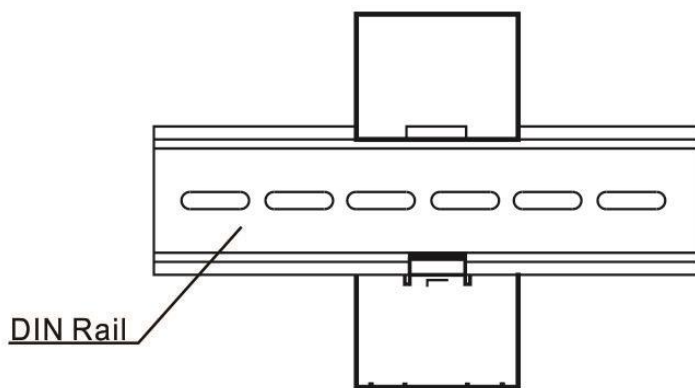
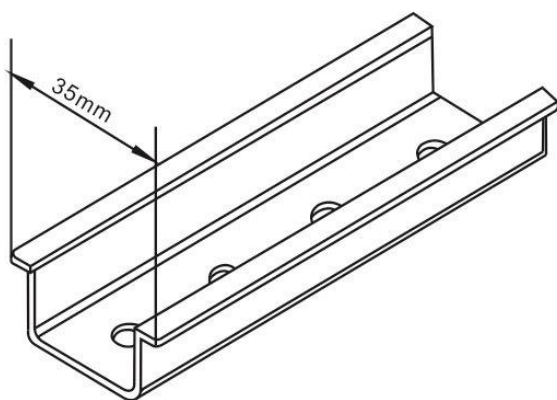

PART 3 Modbus Protocol

Input Registers

Input registers are used to indicate the present values of the measured and calculated electrical quantities. Each parameter is held in two consecutive 16 bit register. The following table details the 3X register address, and the values of the the address bytes within the message. A (*) in the column indicated the parameter is valid for the particular wiring system, Any parameter with a cross (X) will return the value zero. Each parameter is held in the 3X registers. Modbus Protocol function code 04 is used to access all parameters.

For example, to request: Amps 1 Start address = 0006

 No.of registers = 0002

 Amps 2 Start address = 0008

 No. Of register = 0002

Each request for data must be restricted to 30 parameters or less. Exceeding the 30 parameter limit will cause a Modbus Protocol exception code to be returned.

Address (Register)	Input Register Parameter				Modbus Protocol Start Address Hex	
	Description	Length (bytes)	Data Format	Units	Hi Byte	Lo Byte
30053	Total system power.	4	Float	W	00	34
30073	Total Import kWh	4	Float	kWh	00	48
30075	Total Export kWh.	4	Float	kWh	00	4A
30343	Total kWh (1)	4	Float	kWh	01	56
30385	resettable total active energy (1)	4	Float	kWh	01	80
30389	resettable import active energy	4	Float	kWh	01	84
30391	resettable export active energy	4	Float	kWh	01	86
31281	Total import active power	4	Float	W	05	00
31283	Total export active power	4	Float	W	05	02

Notes: 1. Total kWh equals to Import + export.

Holding Registers

Holding register are used to store and display instrument configuration settings. All holding registers not listed in the table below should be considered as reserved for manufacturer use and no attempt should be made to modify their values.

The holding register parameters may be viewed or changed using the Modbus Protocol. Each parameter is held in two consecutive 4X registers. Modbus Protocol Function Code 03 is used to read the parameter and Function code 10 is used to write. Write only to one parameter per message.

Address Register	Parameter Number	Parameter	Modbus Protocol		Valid range	Mode
			Start Address Hex			
			High Byte	Low Byte		
40019	10	Parity / Stop	00	12	Write the network port parity/stop bits for MODBUS Protocol, where: 0 = One stop bit and no parity, default. 1 = One stop bit and even parity. 2 = One stop bit and odd parity. 3 = Two stop bits and no parity. Length : 4 byte Data Format : Float	r/w
40021	11	Modbus Address	00	14	Write the network port node address: 1 to 247 for MODBUS Protocol, default 1. Length : 4 byte Data Format : Float	r/w
40025	13	Password	00	18	Read: get password Write: change password Length : 4 byte	r/w

					Data Format : Float	
40029	15	Network Baud Rate	00	1C	<p>Write the network port baud rate for MODBUS Protocol, where:</p> <p>0 = 2400 baud.</p> <p>1 = 4800 baud.</p> <p>2 = 9600 baud (default).</p> <p>5 = 1200 band</p> <p>Length : 4 byte</p> <p>Data Format : Float</p>	r/w
40059	30	Time for scrolling display	00	3A	<p>Default: 0, Unit: s</p> <p>Range: 0~30, (0 means close scrolling)</p> <p>Length : 4 byte</p> <p>Data Format : Float</p>	r/w
40061	31	Time of back light	00	3C	<p>Default: 0. Unit: min</p> <p>Rang :0~120. (0 means the back light will work all the time)</p> <p>Length : 4byte</p> <p>Data Format : Float</p>	r/w
461457	30729	Reset	F0	10	<p>00 03: reset the resettable energy</p> <p>Length : 2 byte</p> <p>Data Format:Hex</p>	wo